

Acceleration sensors

With SIL2/PLd relay output for limit monitoring

Analog / CANopen®

GAM900S



GAM900S

Features

- Acceleration sensor for safety applications
- Safety limit monitoring with relay output according to SIL2/PLd
- Output of acceleration via analog / CANopen®
- Redundant 3 axes detection, MEMS based
- Measuring range ± 2 g
- Connection: connector M12
- Offshore capability (plastic housing)

Technical data - electrical ratings

Voltage supply	10...30 VDC
Reverse polarity protection	Yes
Consumption w/o load	≤ 200 mA (24 VDC)
Initializing time	≤ 2000 ms after power on
Interfaces	CANopen®, Analog 4...20 mA (0...10 V optional)
Frequency bands	4 (configurable)
Measuring range	± 2 g
Resolution	< 4 mg
Accuracy 3σ (with band pass filtering)	=60 mg (in the range of ± 1000 mg) =15 mg (in the range of ± 250 mg)
Interference immunity	DIN EN 61000-6-2 EN 61326-3-1
Emitted interference	DIN EN 61000-6-4
Status indicator	DUO-LED integrated in housing
Approvals	UL approval / E63076, PLd according to EN ISO 13849-1:2008+AC:2009 SIL CL2 according to EN 62061:2005 +AC:2010 +A1:2013 SIL2 according to IEC 61508-1..7:2010, Certified by TÜV Rheinland

Technical data - mechanical design

Dimensions W x H x L	55 x 30 x 90 mm
Protection DIN EN 60529	IP 67
Materials	GAM900S-M: Aluminium GAM900S-P: Glass-fiber reinforced plastic
Operating temperature	-40...+75 °C
Resistance	DIN EN 60068-2-6 Vibration 20 g, 60-2000 Hz DIN EN 60068-2-27 Shock 100 g, 6 ms
Weight approx.	200 g (plastic), 250 g (aluminium)
Connection	Connector M12

Safety-relevant key characteristics

Performance Level (ISO 13849)	PLd
Category (ISO 13849)	3
MTTF _d (ISO 13849)	393 years
DC _{avg} (ISO 13849)	86 %
TM (service life, ISO 13849)	20 years
Safety Integrity Level (IEC 61508 / EN 62061)	SIL2 / SIL CL2
PFH _D (IEC 61508 / EN 62061)	2,5 E-09 1/h
PFD _{avg} (IEC 61508)	2,1 E-04
Error reaction time	< 50 ms

Acceleration sensors

With SIL2/PLd relay output for limit monitoring

Analog / CANopen®

GAM900S

Part number

GAM900S - 5-pin

GAM900S-

M	3	2G	.	B	0C	.ACB	...
---	---	----	---	---	----	------	-----

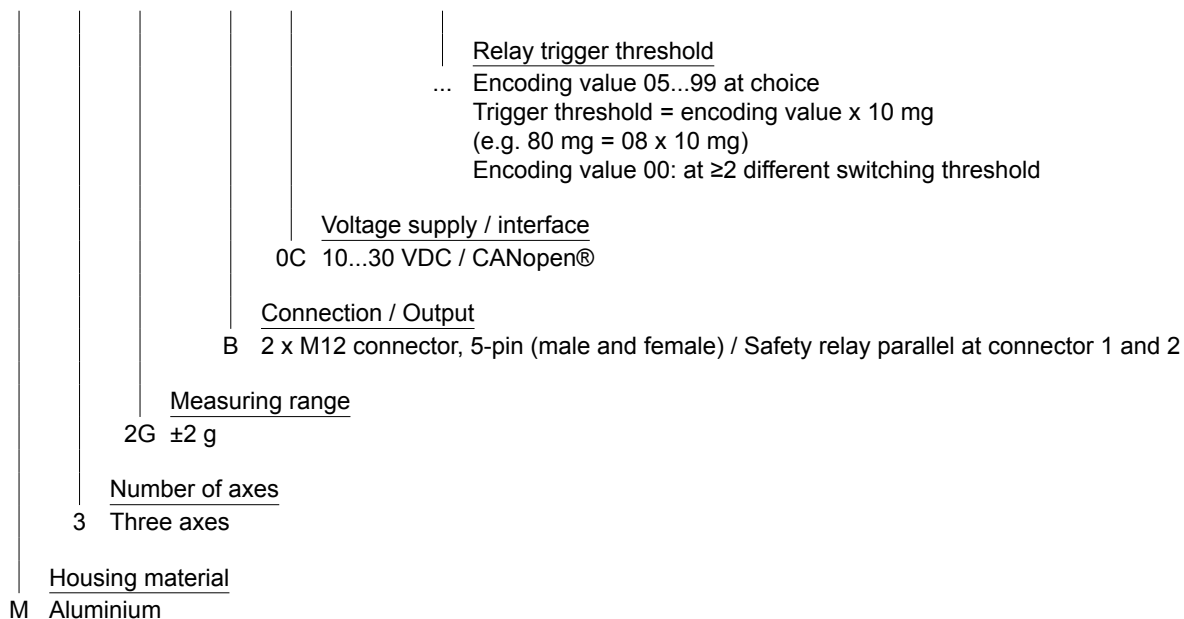

Acceleration sensors

With SIL2/PLd relay output for limit monitoring

Analog / CANopen®

GAM900S

Terminal assignment

Standard / no option, connector M12, 12-pin

Connector 1

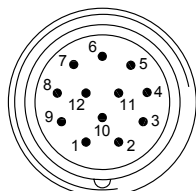

Pin	Description
1	GND
2	Test input
3	UB
4	Analog Ground
5	Analog output X
6	Analog output Y
7	Relay 1 / Safety contact NO*
8	CAN Ground
9	Relay 1 / Safety contact CO*
10	n.c.
11	CAN Low
12	CAN High

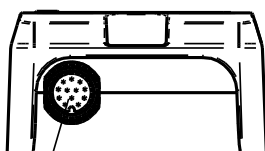

Connector 1

Standard / no option, connector 2 x M12, 12-pin

Connector 1

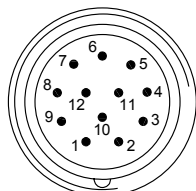

Pin	Description
1	GND
2	Test input
3	UB
4	Analog Ground
5	Analog output X
6	Analog output Y
7	Relay 1 / Safety contact NO*
8	CAN Ground
9	Relay 1 / Safety contact CO*
10	Relay 1 / Contact NC*
11	CAN Low
12	CAN High

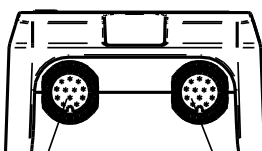

Connector 1

Connector 2

Connector 2

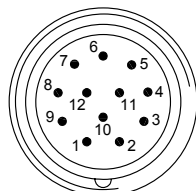

Pin	Description
1	Relay 2 / Contact CO*
2	Relay 3 / Contact NO*
3	Relay 3 / Contact CO*
4	Relay 3 / Contact NC*
5	Relay 4 / Contact NO*
6	Relay 4 / Contact CO*
7	Relay 4 / Contact NC*
8	CAN Ground
9	Relay 2 / Contact NO*
10	Relay 2 / Contact NC*
11	CAN Low
12	CAN High

* Customer-specific relay configuration on request

Acceleration sensors

With SIL2/PLd relay output for limit monitoring

Analog / CANopen®

GAM900S

Terminal assignment

Option -3500, connector 2 x M12, 12-pin / Voltage supply and redundant safety relay at connector 2

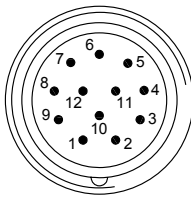
Connector 1	Pin	Description
	1	GND
	2	Test input
	3	UB
	4	Analog ground
	5	Analog output X
	6	Analog output Y
	7	Relay 1 / Safety contact NO*
	8	CAN Ground
	9	Relay 1 / Safety contact CO*
	10	Relay 1 / Contact NC*
	11	CAN Low
	12	CAN High

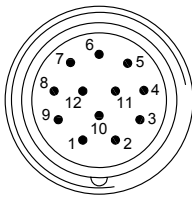
Connector 2	Pin	Description
	1	Relay 2 / Contact CO*
	2	Relay 1a / Safety contact NO
	3	Relay 1a / Safety contact CO
	4	Relay 1a / Contact NC
	5	n.c.
	6	GND
	7	UB
	8	CAN Ground
	9	Relay 2 / Contact NO*
	10	Relay 2 / Contact NC*
	11	CAN Low
	12	CAN High

Option -3501, connector 2 x M12, 12-pin / Safety relay parallel at connector 1 and 2

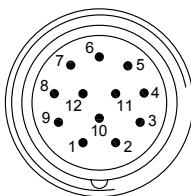
Connector 1	Pin	Description
	1	GND
	2	Test input
	3	UB
	4	Analog ground
	5	Analog output X
	6	Analog output Y
	7	Relay 1 / Safety contact NO*
	8	CAN Ground
	9	Relay 1 / Safety contact CO*
	10	Relay 1 / Contact NC*
	11	CAN Low
	12	CAN High

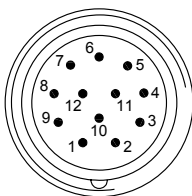
Connector 2	Pin	Description
	1	Relay 2 / Contact CO*
	2	Relay 1a / Safety contact NO
	3	Relay 1a / Safety contact CO
	4	Relay 1a / Contact NC
	5	Relay 4 / Contact NO*
	6	Relay 4 / Contact CO*
	7	Relay 4 / Contact NC*
	8	CAN Ground
	9	Relay 2 / Contact NO*
	10	Relay 2 / Contact NC*
	11	CAN Low
	12	CAN High

Option -3502, connector 2 x M12, 12-pin / Voltage supply at connector 2

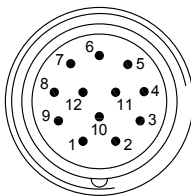
Connector 1	Pin	Description
	1	GND
	2	Test input
	3	UB
	4	Analog ground
	5	Analog output X
	6	Analog output Y
	7	Relay 1 / Safety contact NO*
	8	CAN Ground
	9	Relay 1 / Safety contact CO*
	10	n.c.
	11	CAN Low
	12	CAN High

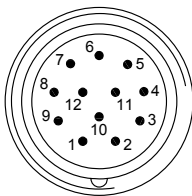
Connector 2	Pin	Description
	1	Relay 2 / Contact CO*
	2	Relay 3 / Contact NO*
	3	Relay 3 / Contact CO*
	4	Relay 3 / Contact NC*
	5	n.c.
	6	GND
	7	UB
	8	CAN Ground
	9	Relay 2 / Contact NO*
	10	Relay 2 / Contact NC*
	11	CAN Low
	12	CAN High

* Customer-specific relay configuration on request

Acceleration sensors

With SIL2/PLd relay output for limit monitoring
Analog / CANopen®

GAM900S

Terminal assignment

Standard / no option, connector 2 x M12, 5-pin (A-coded)

Male

Pin	Description
1	Relay 1 / Safety contact CO*
2	Relay 1a / Safety contact CO
3	GND
4	Test-Input
5	UB

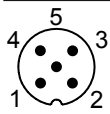

Female

Pin	Description
1	Relay 1 / Safety contact NO*
2	Relay 1a / Safety contact NO
3	CAN GND
4	CAN High
5	CAN Low

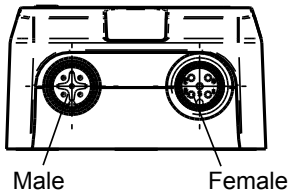
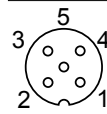

* Customer-specific relay configuration on request

Acceleration sensors

With SIL2/PLd relay output for limit monitoring

Analog / CANopen®

GAM900S

Configuration profile

Band	Analog 1 CANopen 1	Analog 2 CANopen 2	CANopen 3	CANopen 4
Direction	X	Y	Z	X,Y
Range Analog	±0.5 g	±0.5 g	–	–
Range CANopen	±2 g	±2 g	±2 g	±2 g
Resolution Analog	0.244 mg	0.244 mg	–	–
Resolution CANopen	1 mg	1 mg	1 mg	1 mg
Filter type	Bandpass	Bandpass	Bandpass	Bandpass
Filter order	4	4	4	4
Bandwidth	0.05...25 Hz	0.05...25 Hz	0.05...25 Hz	0.05...25 Hz
Relay ID	2	2	–	1 (safety)
Relay attack value	see part no.	see part no.	–	see part no.
Relay attack time	0 s	0 s	–	0 s
Relay decay value	100 %	100 %	–	100 %
Relay decay time	1 s	1 s	–	1 s

Different configurations on request.

Installation position

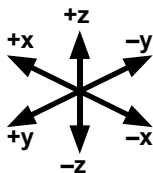

Acceleration sensors

With SIL2/PLd relay output for limit monitoring
Analog / CANopen®

GAM900S

Dimensions

GAM900S - plastic housing, 1x connector M12

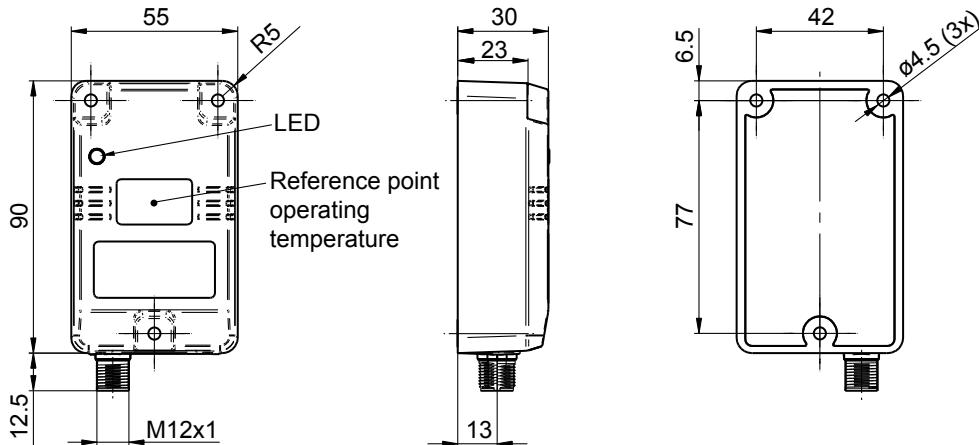

GAM900S - plastic housing, 2x connector M12

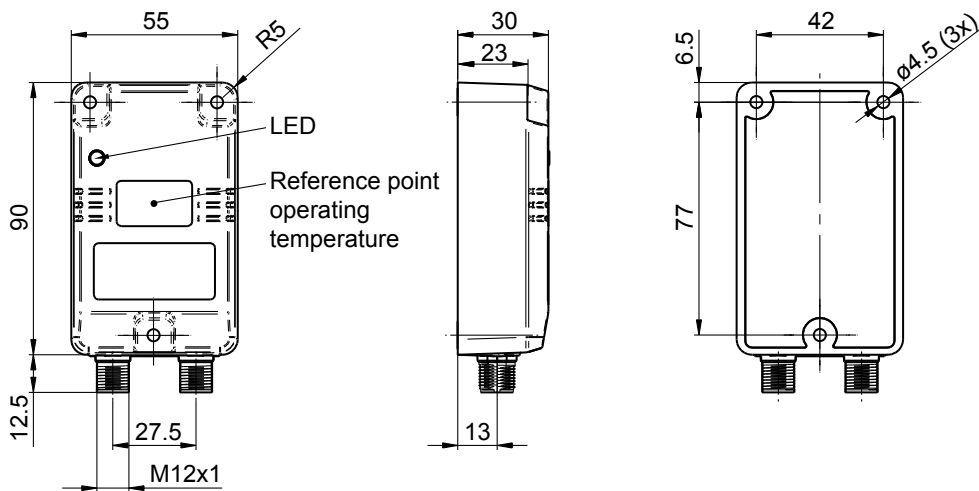

GAM900S - aluminium housing, 1x connector M12

